



HHS - SINGLE ACTING HOLLOW PISTON CYLINDERS



Capacities from 11 to 102 tonnes

Stroke lengths from 25 to 152mm

Working pressure 700 Bar

The HHS single acting hollow piston cylinder range is extremely versatile for use in tooling, maintenance and tensioning applications. Specifically designed with a hollow piston to enable a rod or cable to be passed through the entire cylinder length for applications where a pulling force is required, the HHS range is used extensively in post-tensioning and pre-stressing applications as well as testing of various bonded or mechanical anchoring systems. HHS cylinders can also be used for general lifting applications, when fitted with readily available interchangeable hardened steel piston rod saddles.

- >> Spring assisted return
- >> Nitrocarburised piston rod
- >> Low friction bearing surfaces
- >> Anti-extrusion seals
- >> Optional piston rod saddles (see page 25)
- >> Collar thread protector supplied as standard

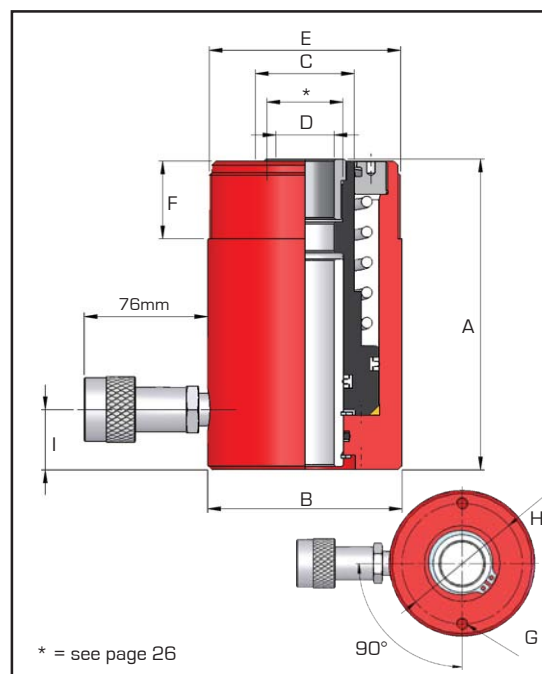

Model number	Capacity tonnes	Stroke mm	Oil cap. cm ³	Cyl. eff. area cm ²	Weight kg
HHS101	11	25	39	15.8	2.8
HHS102	11	50	79	15.8	3.0
HHS106	11	152	240	15.8	10.2
HHS202	23	50	167	33.3	7.0
HHS206	23	150	500	33.3	13.8
HHS302	33	50	233	46.7	10.6
HHS306	33	152	710	46.7	19.2
HHS603	61	76	651	85.7	28.0
HHS606	61	150	1285	85.7	40.6
HHS1003	102	76	1088	143.1	64.0
HHS1006	102	150	2147	143.1	75.0

Dimensions in mm (unless otherwise stated)									
A	B	C	D	E	F	G	H	I	
110	70	38	20	2 3/4"-16un	30	M8	51	19	
140	70	38	20	2 3/4"-16un	30	M8	51	19	
297	70	38	20	2 3/4"-16un	30	M8	51	19	
160	100	51	30	3 7/8"-12un	40	M8	82.5	31	
306	100	51	30	3 7/8"-12un	40	M8	82.5	31	
165	115	60	35	4 1/2"-12un	40	M8	92	31	
320	115	60	35	4 1/2"-12un	40	M8	92	31	
226	160	92	55	6 1/4"-12un	59	M12	130	31	
315	160	92	55	6 1/4"-12un	59	M12	130	31	
276	213	127	81	8 3/8"-12un	60	M16	178	45	
350	213	127	81	8 3/8"-12un	60	M16	178	45	